

Aluminum Capacitors Solid Axial

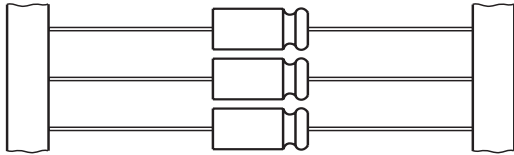
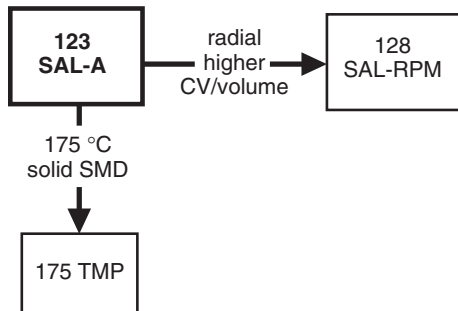


Fig.1 Component outline.



FEATURES

- Polarized aluminum electrolytic capacitors, solid electrolyte MnO₂
- Axial leads, aluminum case, ceramic seal, blue insulation sleeve
- SAL-A: standard version
- SAL-AG: epoxy filled shock-proof version up to 10000 g
- Extremely long useful life: 20000 hours at 125 °C
- Extended usable temperature range up to 200 °C
- Excellent low temperature impedance and ESR behaviour
- Charge and discharge proof, application with 0 Ω resistance allowed
- Reverse DC voltage up to 0.3 × U_R allowed
- AC voltage up to 0.8 × U_R allowed
- Advanced technology to achieve high reliability and high stability.

APPLICATIONS

- EDP, telecommunication, general industrial, automotive, military and space
- Smoothing, filtering, buffering, timing
- For power supplies, DC/DC converters.

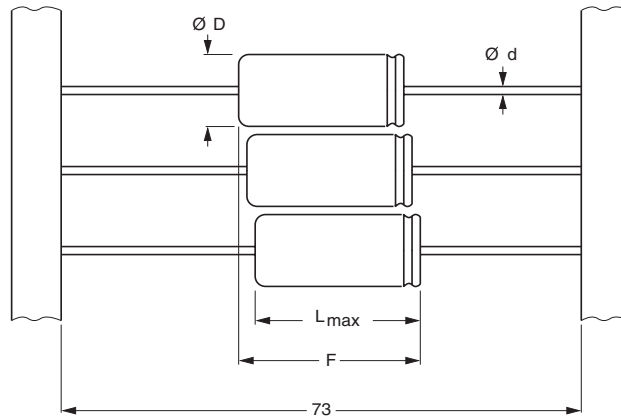
MARKING

The capacitors are marked (where possible) with the following information:

- Rated capacitance (in μF).
- Tolerance code on rated capacitance, code letter in accordance with IEC 60062 (M = ±20%, K = ±10%).
- Rated voltage (in V) at corresponding maximum temperature
- Date code in accordance with IEC 60062
- Name of manufacturer
- Code for factory of origin
- Band to indicate the negative terminal.
- '+' sign to identify the positive terminal.
- Series number.

QUICK REFERENCE DATA	
DESCRIPTION	VALUE
Maximum case size (ØD × L in mm)	6.7 × 15.3 to 12.9 × 32.0
Rated capacitance range (E6 series), C _R	1.0 to 1500 μF
Tolerance on C _R	±20%; ±10% on request
Rated voltage range, U _R	6.3 to 40 V
Category temperature range	-55 to +125 °C
Usable temperature range	-80 to +200 °C
Endurance test at 155 and 125 °C	5000 and 8000 hours
Useful life at 125 °C	20000 hours
Useful life at 40 °C, I _R applied	450000 hours
Shelf life at 0 V, 125 °C	500 hours
Based on sectional specification	IEC 60384-4/EN130300
Climatic category IEC 60068	55/125/56

SELECTION CHART FOR C_R, U_R AND RELEVANT MAXIMUM CASE SIZES (∅D × L in mm)						
C _R (μF)	U _R (V) at T _{amb} = 85 °C					
	6.3	10	16	25	35	40
	U _C (V) at T _{amb} = 125 °C					
	6.3	10	16	25	25	25
1.0	–	–	–	–	6.7 × 15.3	–
1.5	–	–	–	–	6.7 × 15.3	–
2.2	–	–	–	–	6.7 × 15.3	6.7 × 15.3
3.3	–	–	–	–	6.7 × 15.3	6.7 × 15.3
4.7	–	–	–	–	6.7 × 15.3	6.7 × 15.3
6.8	–	–	–	–	6.7 × 15.3	6.7 × 15.3
10	–	–	6.7 × 15.3	6.7 × 15.3	7.6 × 20.4	7.6 × 20.4
15	–	–	6.7 × 15.3	6.7 × 15.3	7.6 × 20.4	7.6 × 20.4
22	–	–	6.7 × 15.3	7.6 × 20.4	7.6 × 20.4	9.4 × 23.3
33	–	6.7 × 15.3	7.6 × 20.4	7.6 × 20.4	9.4 × 23.3	9.4 × 23.3
47	6.7 × 15.3	6.7 × 15.3	7.6 × 20.4	7.6 × 20.4	9.4 × 23.3	10.3 × 32.0
68	6.7 × 15.3	7.6 × 20.4	7.6 × 20.4	9.4 × 23.3	10.3 × 32.0	10.3 × 32.0
100	–	7.6 × 20.4	9.4 × 23.3	9.4 × 23.3	12.9 × 32.0	12.9 × 32.0
150	7.6 × 20.4	9.4 × 23.3	9.4 × 23.3	10.3 × 32.0	12.9 × 32.0	–
220	–	9.4 × 23.3	10.3 × 32.0	12.9 × 32.0	–	–
330	9.4 × 23.3	10.3 × 32.0	10.3 × 32.0	12.9 × 32.0	–	–
470	–	10.3 × 32.0	12.9 × 32.0	–	–	–
680	10.3 × 32.0	12.9 × 32.0	12.9 × 32.0	–	–	–
1000	12.9 × 32.0	12.9 × 32.0	–	–	–	–
1500	12.9 × 32.0	–	–	–	–	–

DIMENSIONS in millimeters AND AVAILABLE FORMS


BA: taped in box (ammopack).

BR: taped on reel.

Fig.2 Forms: BA and BR.

Table 1

DIMENSIONS in millimeters, MASS AND PACKAGING QUANTITIES						
CASE		F _{max}	∅d	MASS ⁽²⁾ (g)	PACKAGING QUANTITIES	
MAXIMUM SIZE ∅D × L ⁽¹⁾	CODE				FORM BA	FORM BR
6.7 × 15.3	1	20.0	0.6	≈1.05	100	800
7.6 × 20.4	2A	22.5	0.6	≈1.55	100	800
9.4 × 23.3	4	25.0	0.6	≈2.6	100	500
10.3 × 32.0	5	35.0	0.8	≈4.2	100	500
12.9 × 32.0	6	35.0	0.8	≈7	100	400

Notes

- For epoxy-filled versions add 1 mm to stated L_{max}.
- Add 10% for SAL-AG epoxy-filled versions.
- Detailed tape dimensions see section 'PACKAGING'.



ELECTRICAL DATA	
SYMBOL	DESCRIPTION
C_R	rated capacitance at 100 Hz
I_R	max. RMS ripple current, no necessary DC voltage applied
I_{L5}	max. leakage current after 5 minutes at U_R
$\tan \delta$	max. dissipation factor at 100 Hz
ESR	max./typ. equivalent series resistance at 100 Hz
Z	max. impedance at 100 kHz

ORDERING EXAMPLE

Electrolytic capacitors 123 series

10 μ F/16 V; $\pm 20\%$

Maximum case size: $\varnothing 6.7 \times 15.3$ mm; Form BR

Catalog number: 2222 123 25109.

Note

- Unless otherwise specified, all electrical values in Table 2 apply at $T_{amb} = 20$ to 25 °C, $P = 86$ to 106 kPa, $RH = 45$ to 75% .

Table 2

ELECTRICAL DATA AND ORDERING INFORMATION for 123 series															
U_C (V)	U_R (V)	C_R 100 Hz (μ F)	MAX. CASE SIZE $\varnothing D \times L$ (mm)	I_R 100 Hz 125 °C (mA)	I_R 10 kHz 85 °C (mA)	I_R 100 kHz 40 °C (mA)	I_{L5} 5 min (μ A)	$\tan \delta$ 100 Hz	MAX. ESR 100 Hz (Ω)	TYP. ESR 100 Hz (Ω)	Z 100 kHz (Ω)	CATALOG NUMBER 2222 123			
												SAL-A FORM BA tol. $\pm 20\%$	SAL-A FORM BR tol. $\pm 20\%$	SAL-AG ⁽¹⁾ FORM BA tol. $\pm 10\%$ level S	SAL-AG ⁽¹⁾ FORM BA tol. $\pm 20\%$
6.3	6.3	47	6.7 × 15.3	58	440	640	15	0.18	7.6	3.0	1.2	13479	23479	83479	63479
		68	6.7 × 15.3	83	520	760	21	0.18	5.3	2.6	1.2	13689	23689	83689	63689
		150	7.6 × 20.4	160	870	1270	47	0.18	2.4	1.5	1.0	13151	23151	83151	63151
		330	9.4 × 23.3	330	1470	2140	104	0.18	1.1	0.55	0.4	13331	23331	83331	63331
		680	10.3 × 32.0	680	2340	3410	214	0.18	0.55	0.28	0.3	13681	23681	83681	63681
		1000	12.9 × 32.0	940	3180	4640	315	0.18	0.36	0.19	0.2	13102	23102	83102	63102
		1500	12.9 × 32.0	1220	4140	6020	473	0.18	0.24	0.13	0.2	13152	23152	83152	63152
		10	10	33	6.7 × 15.3	63	360	530	17	0.18	11	3.8	1.2	14339	24339
47	6.7 × 15.3			83	440	640	24	0.18	7.6	4.0	1.2	14479	24479	84479	64479
68	7.6 × 20.4			110	590	850	34	0.18	5.3	2.5	1.0	14689	24689	84689	64689
100	7.6 × 20.4			160	710	1040	50	0.18	3.6	1.8	1.0	14101	24101	84101	64101
150	9.4 × 23.3			240	990	1450	75	0.18	2.4	0.9	0.4	14151	24151	84151	64151
220	9.4 × 23.3			350	1180	1720	110	0.18	1.7	0.6	0.4	14221	24221	84221	64221
330	10.3 × 32.0			490	1650	2410	165	0.18	1.1	0.45	0.3	14331	24331	84331	64331
470	10.3 × 32.0			570	1940	2830	235	0.18	0.8	0.35	0.3	14471	24471	84471	64471
680	12.9 × 32.0			760	2580	3750	340	0.18	0.55	0.25	0.2	14681	24681	84681	64681
1000	12.9 × 32.0			1000	3380	4920	500	0.18	0.36	0.18	0.2	14102	24102	84102	64102
16	16	10	6.7 × 15.3	31	230	330	16	0.14	28	8.0	2.5	15109	25109	85109	65109
		15	6.7 × 15.3	47	280	400	24	0.14	19	5.5	2.5	15159	25159	85159	65159
		22	6.7 × 15.3	63	340	490	35	0.14	13	5.5	2.5	15229	25229	85229	65229
		33	7.6 × 20.4	89	470	680	55	0.14	8.4	3.0	2.0	15339	25339	85339	65339
		47	7.6 × 20.4	120	560	810	75	0.14	5.9	2.6	2.0	15479	25479	85479	65479
		68	7.6 × 20.4	180	670	970	110	0.14	4.1	2.5	2.0	15689	25689	85689	65689
		100	9.4 × 23.3	260	920	1340	160	0.14	2.8	1.5	0.8	15101	25101	85101	65101
		150	9.4 × 23.3	310	1060	1550	240	0.16	2.1	0.7	0.8	15151	25151	85151	65151
		220	10.3 × 32.0	420	1420	2060	350	0.16	1.5	0.55	0.6	15221	25221	85221	65221
		330	10.3 × 32.0	510	1740	2530	500	0.16	1.0	0.35	0.6	15331	25331	85331	65331
		470	12.9 × 32.0	680	2280	3330	750	0.16	0.7	0.25	0.4	15471	25471	85471	65471
		680	12.9 × 32.0	850	2870	4170	870	0.16	0.5	0.18	0.4	15681	25681	85681	65681
25	25	10	6.7 × 15.3	43	230	330	25	0.14	28	13.0	5	16109	26109	86109	66109
		15	6.7 × 15.3	60	280	400	35	0.14	19	10.0	5.0	16159	26159	86159	66159
		22	7.6 × 20.4	88	370	550	55	0.14	13	7	2.5	16229	26229	86229	66229
		33	7.6 × 20.4	130	470	680	85	0.14	8.4	5	2.5	16339	26339	86339	66339
		47	7.6 × 20.4	160	560	810	100	0.14	5.9	3.5	2.5	16479	26479	86479	66479
		68	9.4 × 23.3	230	760	1110	170	0.14	4.1	1.8	1.0	16689	26689	86689	66689
		100	9.4 × 23.3	250	860	1250	250	0.16	3.2	1.0	1.0	16101	26101	86101	66101
		150	10.3 × 32.0	350	1200	1740	400	0.16	2.1	1.2	0.8	16151	26151	86151	66151
		220	12.9 × 32.0	460	1560	2270	550	0.16	1.5	0.85	0.6	16221	26221	86221	66221
		330	12.9 × 32.0	600	2030	2950	800	0.16	1.0	0.60	0.6	16331	26331	86331	66331



ELECTRICAL DATA AND ORDERING INFORMATION for 123 series															
U _C (V)	U _R (V)	C _R 100 Hz (μF)	MAX. CASE SIZE ∅D × L (mm)	I _R 100 Hz 125 °C (mA)	I _R 10 kHz 85 °C (mA)	I _R 100 kHz 40 °C (mA)	I _{L5} 5 min (μA)	Tan δ 100 Hz	MAX. ESR 100 Hz (Ω)	TYP. ESR 100 Hz (Ω)	Z 100 kHz (Ω)	CATALOG NUMBER 2222 123			
												SAL-A FORM BA tol. ±20%	SAL-A FORM BR tol. ±20%	SAL- AG ⁽¹⁾ FORM BA tol. ±10% level S	SAL- AG ⁽¹⁾ FORM BA tol. ±20%
25	35	1.0	6.7 × 15.3	4	55	80	5	0.12	240	105	16.5	10108	20108	80108	60108
		1.5	6.7 × 15.3	7	68	98	5	0.12	160	40.60	11.0	10158	20158	80158	60158
		2.2	6.7 × 15.3	10	82	120	5	0.12	109	30	7.5	10228	20228	80228	60228
		3.3	6.7 × 15.3	14	100	150	7	0.12	73	28	7.5	10338	20338	80338	60338
		4.7	6.7 × 15.3	20	120	170	10	0.12	51	20	7.5	10478	20478	80478	60478
		6.8	6.7 × 15.3	27	140	210	15	0.12	35	16	7.5	10688	20688	80688	60688
		10	7.6 × 20.4	37	200	280	20	0.12	24	10	2.5	10109	20109	80109	60109
		15	7.6 × 20.4	53	240	350	30	0.12	16	8	2.5	10159	20159	80159	60159
		22	7.6 × 20.4	78	290	420	45	0.12	11	7	2.5	10229	20229	80229	60229
		33	9.4 × 23.3	120	410	590	65	0.12	7.2	3	1.0	10339	20339	80339	60339
		47	9.4 × 23.3	140	480	700	95	0.12	5.1	2.9	1.0	10479	20479	80479	60479
		68	10.3 × 32.0	170	570	820	135	0.16	4.7	2.1	0.8	10689	20689	80689	60689
		100	12.9 × 32.0	220	760	1100	200	0.16	3.2	1.7	0.6	10101	20101	80101	60101
		150	12.9 × 32.0	290	990	1440	300	0.16	2.1	1.0	0.6	10151	20151	80151	60151
25	40	2.2	6.7 × 15.3	11	82	120	9	0.12	109	38	7.5	17228	27228	87228	67228
		3.3	6.7 × 15.3	16	100	150	13	0.12	73	25	7.5	17338	27338	87338	67338
		4.7	6.7 × 15.3	22	120	170	19	0.12	51	20	7.5	17478	27478	87478	67478
		6.8	6.7 × 15.3	28	140	210	27	0.12	35	15	7.5	17688	27688	87688	67688
		10	7.6 × 20.4	41	200	280	40	0.12	24	11	2.5	17109	27109	87109	67109
		15	7.6 × 20.4	61	240	350	60	0.12	16	7	2.5	17159	27159	87159	67159
		22	9.4 × 23.3	89	330	480	90	0.12	11	4	1.5	17229	27229	87229	67229
		33	9.4 × 23.3	120	410	590	130	0.12	7.2	2.9	1.0	17339	27339	87339	67339
		47	10.3 × 32.0	160	540	790	190	0.12	5.1	2.7	1.0	17479	27479	87479	67479
		68	10.3 × 32.0	170	570	820	270	0.16	4.7	2.3	0.8	17689	27689	87689	67689
		100	12.9 × 32.0	220	760	1100	400	0.16	3.2	1.6	0.6	17101	27101	87101	67101

Note

- SAL-AG types are epoxy-filled.

ADDITIONAL ELECTRICAL DATA		
PARAMETER	CONDITIONS	VALUE
Voltage		
Surge voltage		$U_S \leq 1.15 \times U_R$
Reverse voltage		$U_{rev} < 0.3 \times U_R$
Maximum peak AC voltage, reverse voltage applied		$\leq 2 V$
Maximum peak AC voltage, without reverse voltage applied	$T_{amb} \leq 85 \text{ °C}$: at $f \leq 0.1 \text{ Hz}$ at $0.1 \text{ Hz} < f \leq 1 \text{ Hz}$ at $1 \text{ Hz} < f \leq 10 \text{ Hz}$ at $10 \text{ Hz} < f \leq 50 \text{ Hz}$ at $f > 50 \text{ Hz}$ $85 \text{ °C} < T_{amb} \leq 125 \text{ °C}$: at $f \leq 0.1 \text{ Hz}$ at $0.1 \text{ Hz} < f \leq 1 \text{ Hz}$ at $1 \text{ Hz} < f \leq 10 \text{ Hz}$ at $10 \text{ Hz} < f \leq 50 \text{ Hz}$ at $f > 50 \text{ Hz}$	$0.30 \times U_R$ $0.45 \times U_R$ $0.60 \times U_R$ $0.65 \times U_R$ $0.80 \times U_R$ $0.15 \times U_R$ $0.22 \times U_R$ $0.30 \times U_R$ $0.32 \times U_R$ $0.40 \times U_R$
Current		
Maximum leakage current	after 5 minutes at U_R and $T_{amb} = 25 \text{ °C}$	$I_{L5} \leq 0.05 C_R \times U_R$ or $2 \mu A$, whichever is greater; see Table 2
Typical leakage current	after 15 s at U_R and $T_{amb} = 25 \text{ °C}$: $U_R = 6.3$ to $16 V$ $U_R = 25$ to $40 V$	$\approx 0.2 \times$ value stated in Table 2 $\approx 0.1 \times$ value stated in Table 2



VOLTAGE

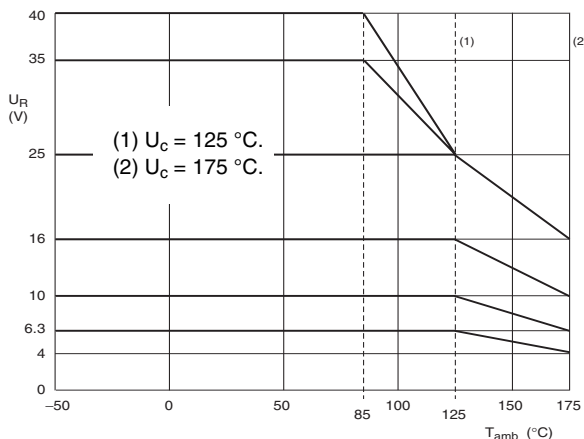


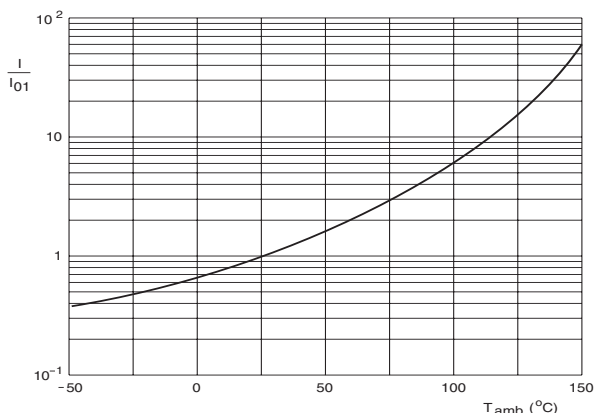
Fig.3 Maximum permissible voltage up to 175 °C.

RIPPLE CURRENT (I_R)						
PARAMETER	T_{amb}					
	25 °C	40 °C	65 °C	85 °C	105 °C	125 °C
I_R multiplier	1.1	1.0	0.88	0.75	0.59	0.37

Note

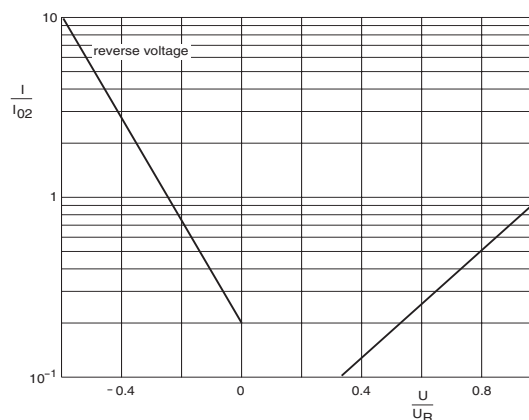
1. Applying the maximum RMS ripple current given in Table 2 will cause a device temperature of 138 °C.
2. The 100 kHz values in Table 2 for other temperatures are to be calculated with the above I_R multipliers.

LEAKAGE CURRENT



I_{01} = leakage current during continuous operation at U_R and $T_{amb} = 25$ °C.

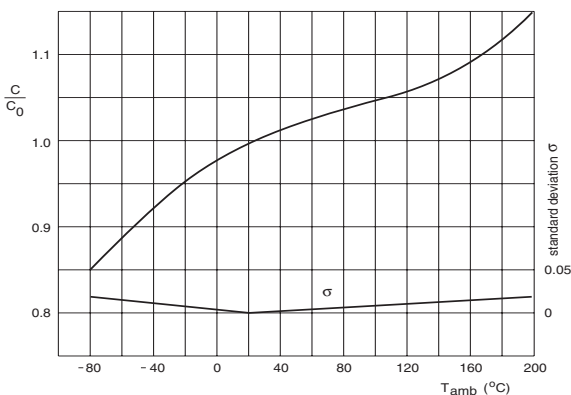
Fig.4 Typical multiplier of leakage current as a function of ambient temperature.



I_{02} = leakage current at U_R at a discrete constant temperature.

Fig.5 Typical multiplier of leakage current as a function of U/U_R .

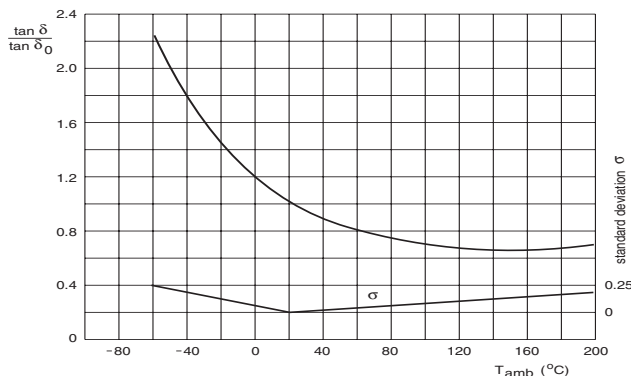
CAPACITANCE (C)



C_0 = capacitance at 25 °C and 100 Hz.

Fig.6 Typical multiplier of capacitance as a function of ambient temperature.

DISSIPATION FACTOR (tan δ)



Typical $\tan \delta$ at 100 Hz and $T_{amb} = 25$ °C: 0.6 × value stated in Table 2.

Fig.7 Typical multiplier of dissipation factor as a function of ambient temperature.

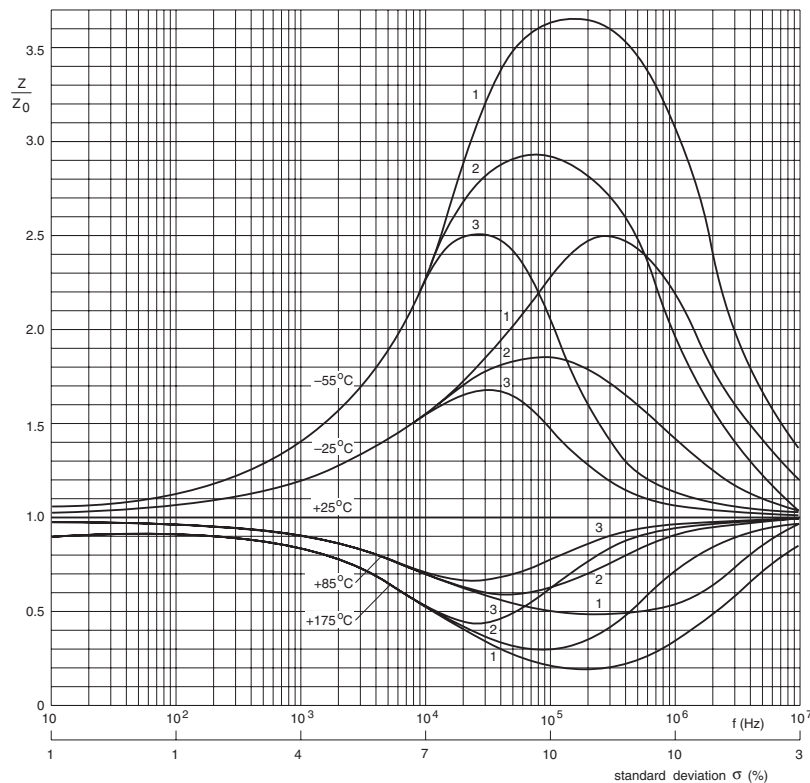


MAXIMUM POWER DISSIPATION	
MAXIMUM CASE SIZE ØD × L (mm)	P _{max} = P ₁₂₅ (W)
6.7 × 15.3	0.13
7.6 × 20.4	0.16
9.4 × 23.3	0.21
10.3 × 32.0	0.26
12.9 × 32.0	0.32

EQUIVALENT SERIES INDUCTANCE (ESL), F = 10 MHZ			
MAXIMUM CASE SIZE ØD × L (mm)	PITCH (mm)	MAX. ESL (nH)	TYP. ESL (nH)
6.7 × 15.3	20.3	30	15 to 23
7.6 × 20.4	25.4	30	16 to 24
9.4 × 23.3	27.9	35	20 to 27
10.3 × 32.0	35.6	40	26 to 33
12.9 × 32.0	35.6	55	32 to 49

IMPEDANCE (Z)

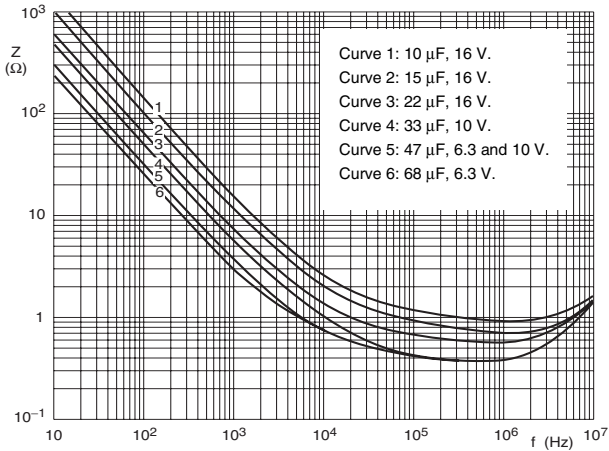
Typical impedance at 100 kHz and T_{amb} = 25 °C: 0.5 × value stated in Table 2.



Curve 1: case ØD × L = 6.7 × 15.3 and 7.6 × 20.4 mm; 16 to 40 V.
 Curve 2: case ØD × L = 6.7 × 15.3 and 7.6 × 20.4 mm; 6.3 to 10 V.
 Curve 3: case ØD × L = 9.4 × 32.0, 10.3 × 32.0 and 12.9 × 32.0 mm.
 Z₀ = initial impedance value at any frequency and T_{amb} = 25 °C.

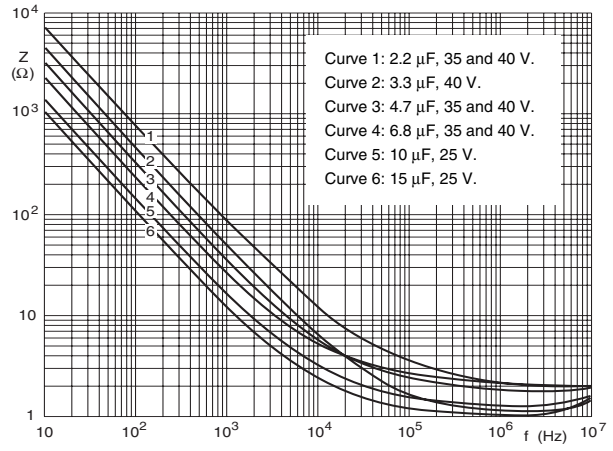
Fig.8 Typical multiplier of impedance as a function of frequency at different ambient temperatures.

IMPEDANCE (Z)



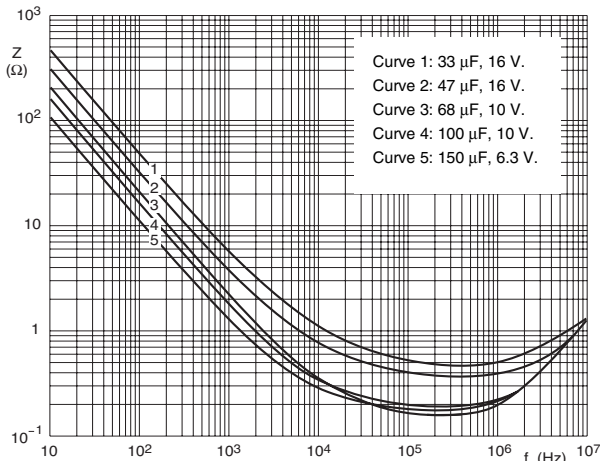
Case $\varnothing D \times L = 6.7 \times 15.3$ mm; $U_R = 6.3$ to 16 V. $T_{amb} = 25$ °C.

Fig.9 Typical impedance as a function of frequency.



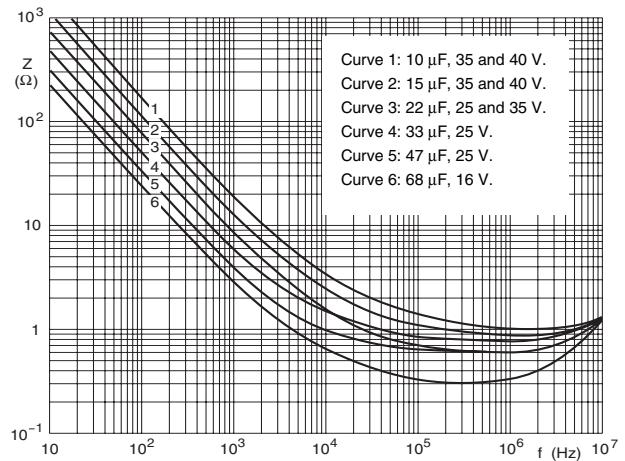
Case $\varnothing D \times L = 6.7 \times 15.3$ mm; $U_R = 25$ to 40 V. $T_{amb} = 25$ °C.

Fig.10 Typical impedance as a function of frequency.



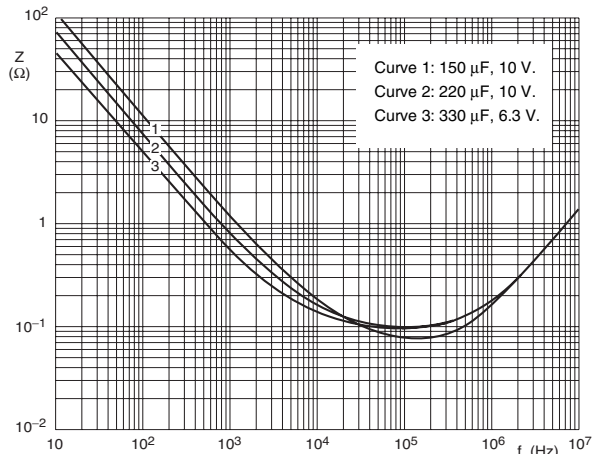
Case $\varnothing D \times L = 6.7 \times 20.4$ mm; $U_R = 6.3$ to 16 V. $T_{amb} = 25$ °C.

Fig.11 Typical impedance as a function of frequency.



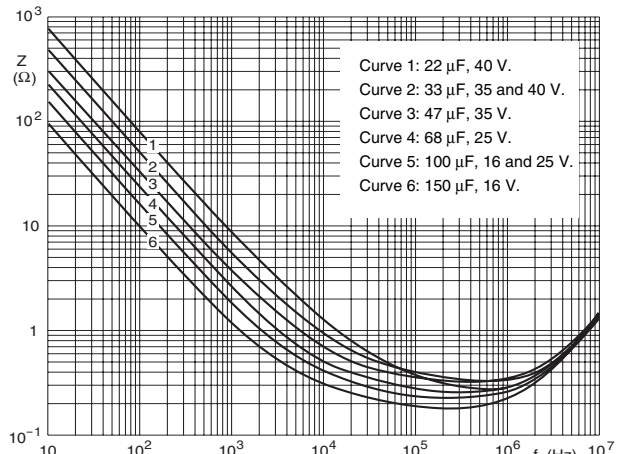
Case $\varnothing D \times L = 6.7 \times 20.4$ mm; $U_R = 16$ to 40 V. $T_{amb} = 25$ °C.

Fig.12 Typical impedance as a function of frequency.



Case $\varnothing D \times L = 9.4 \times 23.3$ mm; $U_R = 6.3$ to 10 V. $T_{amb} = 25$ °C.

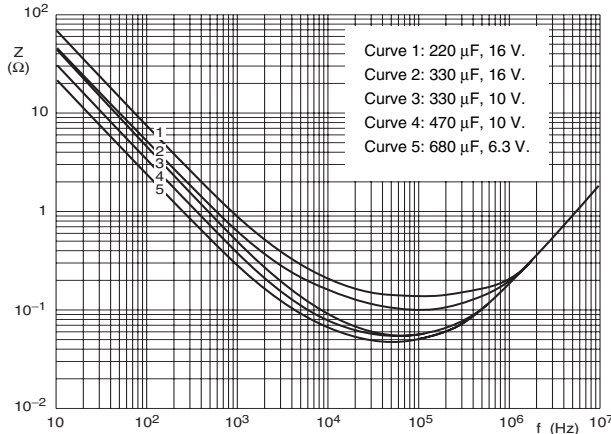
Fig.13 Typical impedance as a function of frequency.



Case $\varnothing D \times L = 9.4 \times 23.3$ mm; $U_R = 16$ to 40 V. $T_{amb} = 25$ °C.

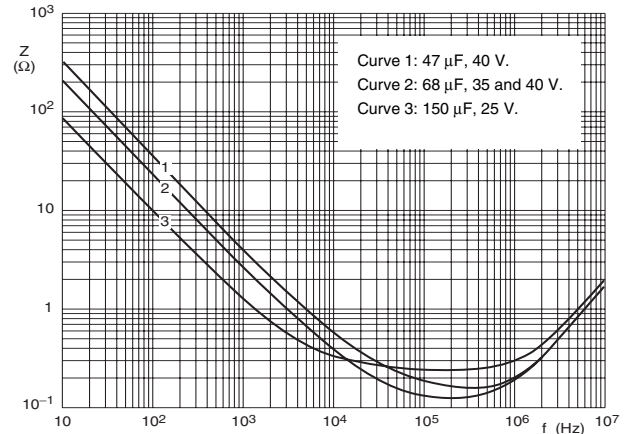
Fig.14 Typical impedance as a function of frequency.

IMPEDANCE (Z)



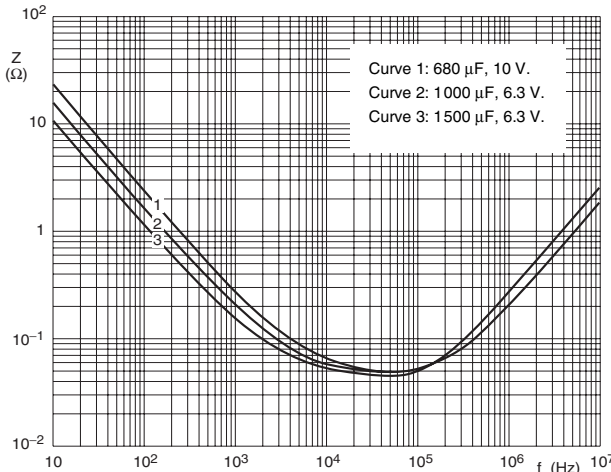
Case $\text{ØD} \times \text{L} = 10.3 \times 32.0 \text{ mm}$; $U_R = 6.3 \text{ to } 16 \text{ V}$. $T_{\text{amb}} = 25 \text{ }^\circ\text{C}$.

Fig.15 Typical impedance as a function of frequency.



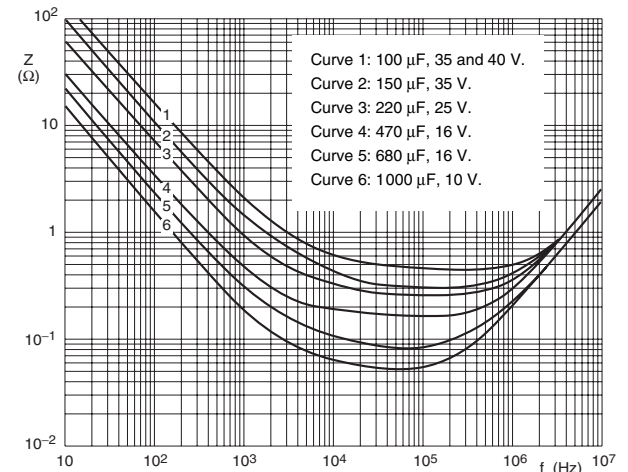
Case $\text{ØD} \times \text{L} = 10.3 \times 32.0 \text{ mm}$; $U_R = 25 \text{ to } 40 \text{ V}$. $T_{\text{amb}} = 25 \text{ }^\circ\text{C}$.

Fig.16 Typical impedance as a function of frequency.



Case $\text{ØD} \times \text{L} = 12.9 \times 32.0 \text{ mm}$; $U_R = 6.3 \text{ to } 10 \text{ V}$. $T_{\text{amb}} = 25 \text{ }^\circ\text{C}$.

Fig.17 Typical impedance as a function of frequency.

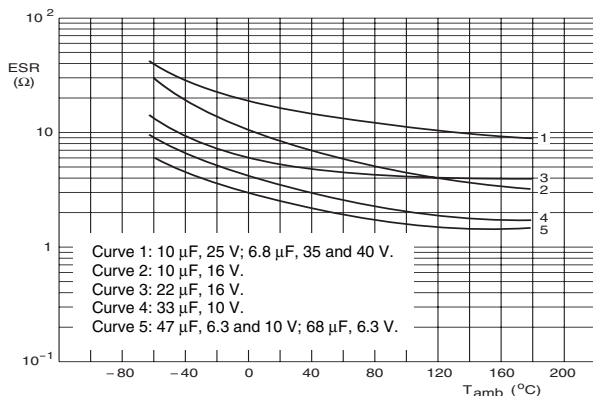


Case $\text{ØD} \times \text{L} = 12.9 \times 32.0 \text{ mm}$; $U_R = 10 \text{ to } 40 \text{ V}$. $T_{\text{amb}} = 25 \text{ }^\circ\text{C}$.

Fig.18 Typical impedance as a function of frequency.

EQUIVALENT SERIES RESISTANCE (ESR)

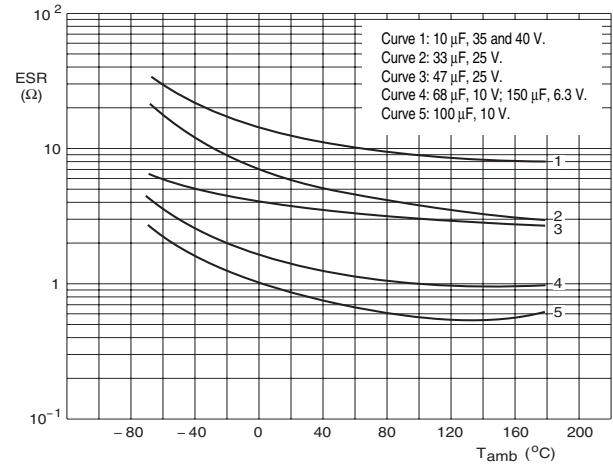
Typical ESR: see Figs 19 to 28; the standard deviation is 20% of each value.



Case $\text{ØD} \times \text{L} = 6.7 \times 15.3 \text{ mm}$.

ESR at 100 Hz.

Fig.19 Typical ESR as a function of ambient temperature.



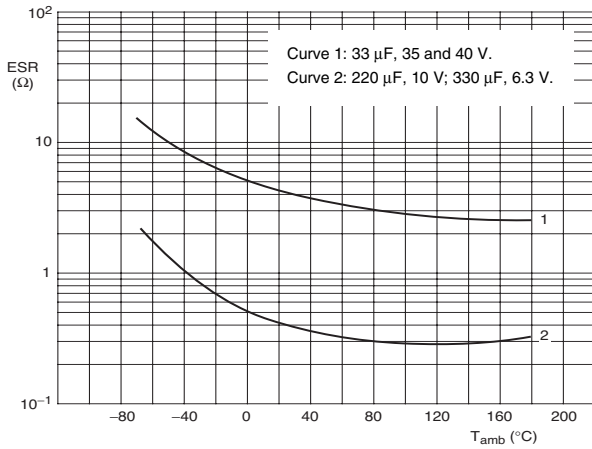
Case $\text{ØD} \times \text{L} = 7.6 \times 20.4 \text{ mm}$.

ESR at 100 Hz.

Fig.20 Typical ESR as a function of ambient temperature.

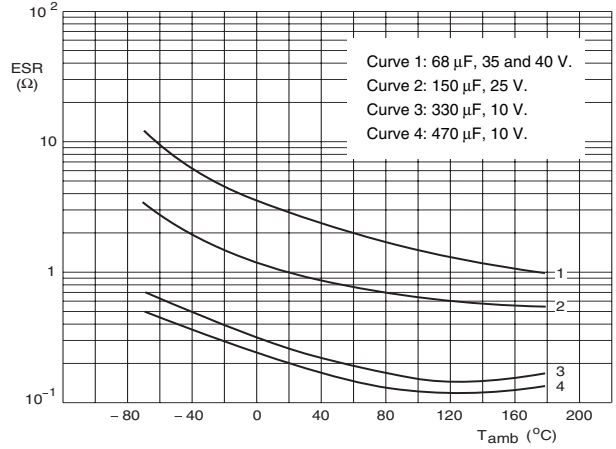


EQUIVALENT SERIES RESISTANCE (ESR)



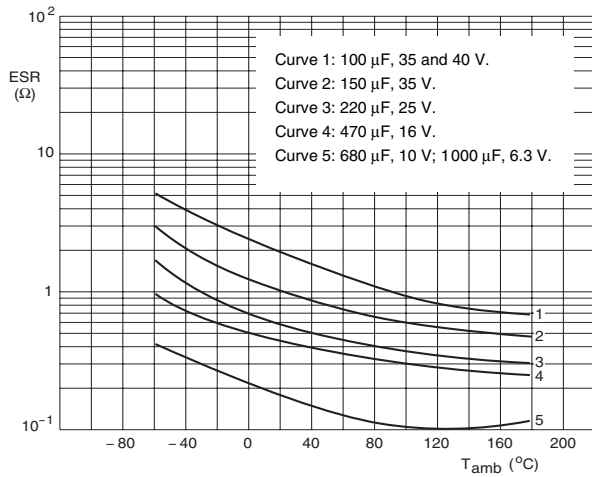
Case ØD × L = 9.4 × 23.3 mm. ESR at 100 Hz.

Fig.21 Typical ESR as a function of ambient temperature.



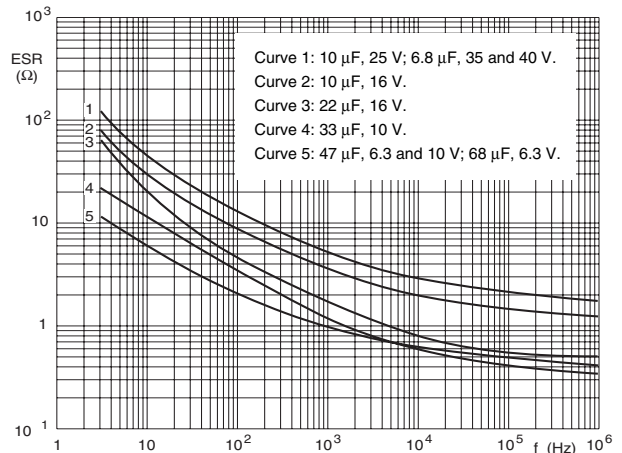
Case ØD × L = 10.3 × 32.0 mm. ESR at 100 Hz.

Fig.22 Typical ESR as a function of ambient temperature.



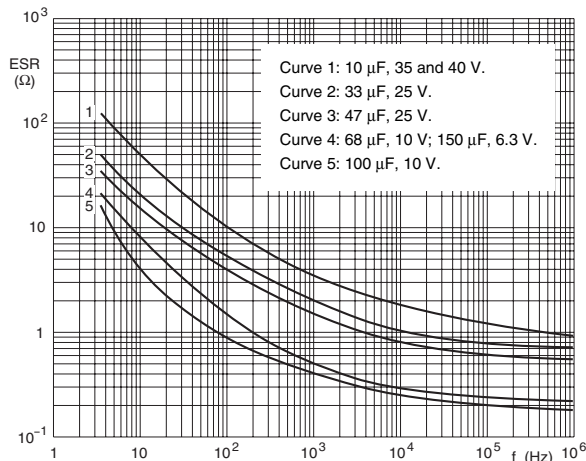
Case ØD × L = 12.9 × 32.0 mm. ESR at 100 Hz.

Fig.23 Typical ESR as a function of ambient temperature.



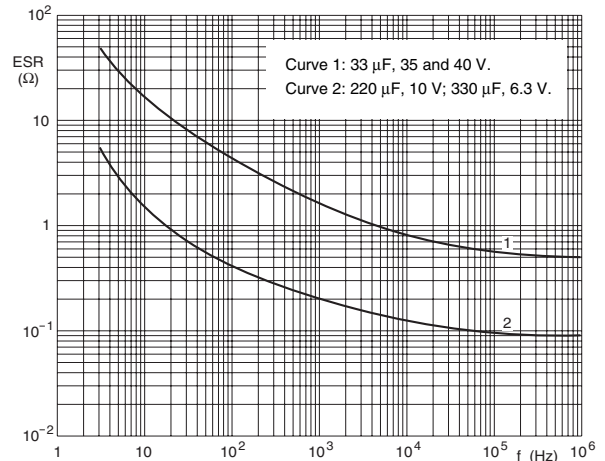
Case ØD × L = 6.7 × 15.3 mm. $T_{amb} = 25$ °C.

Fig.24 Typical ESR as a function of frequency.



Case ØD × L = 6.7 × 20.4 mm. $T_{amb} = 25$ °C.

Fig.25 Typical ESR as a function of frequency.



Case ØD × L = 9.4 × 23.3 mm. $T_{amb} = 25$ °C.

Fig.26 Typical ESR as a function of frequency.

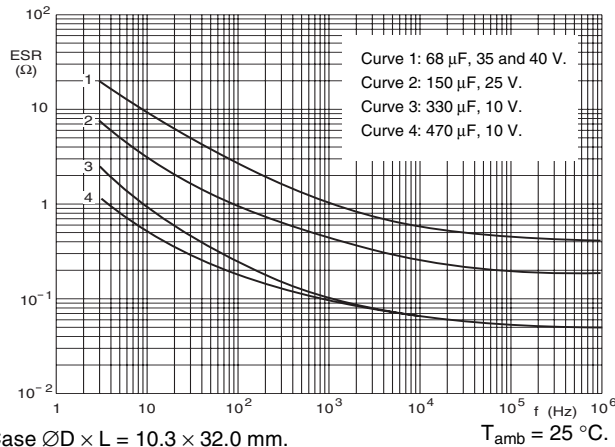
EQUIVALENT SERIES RESISTANCE (ESR)


Fig.27 Typical ESR as a function of frequency.

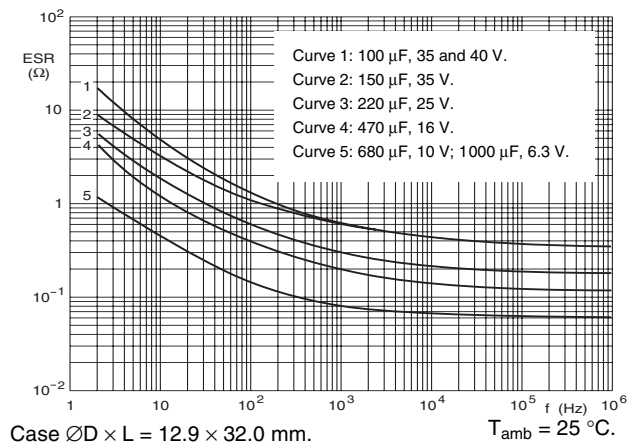


Fig.28 Typical ESR as a function of frequency.

Table 3

TEST PROCEDURES AND REQUIREMENTS			
TEST		PROCEDURE (quick reference)	REQUIREMENTS
NAME OF TEST	REFERENCE		
Endurance	IEC 60384-4/ EN130300 subclause 4.13	$T_{amb} = 125$ °C; $U_R = 6.3$ to 25 V with U_R applied; $U_R = 35$ and 40 V with U_C applied; 10000 hours	$\Delta C/C: \pm 10\%$ $\tan \delta \leq 1.2 \times$ spec. limit $Z \leq 1.2 \times$ spec. limit $I_{L5} \leq$ spec. limit
Useful life	CECC 30302 subclause 1.8.1	$T_{amb} = 125$ °C; I_R applied and $U_R = 6.3$ to 25 V with U_R applied; $U_R = 35$ and 40 V with U_C applied; 20000 hours	$\Delta C/C: \pm 15\%$ $\tan \delta \leq 1.5 \times$ spec. limit $Z \leq 1.5 \times$ spec. limit $I_{L5} \leq$ spec. limit no short or open circuit, no visible damage total failure percentage: < 1%
Shelf life (storage at high temperature)	IEC 60384-4/ EN130300 subclause 4.17	$T_{amb} = 125$ °C; no voltage applied; 500 hours	$\Delta C/C: \pm 10\%$ $\tan \delta \leq 1.2 \times$ spec. limit $I_{L5} \leq 1 \times$ spec. limit
Charge and discharge	IEC 60384-4-2 subclause 9.21	10^6 cycles without series resistance: 0.5 s to U_R ; 0.5 s to ground	$\Delta C/C: \pm 5\%$ no short or open circuit, no visible damage
Shock	IEC 60068-2-27 test Ea	half-sine or saw tooth pulse shape; 50 g; 11 ms; 3 successive shocks in each direction of 3 mutually perpendicular axes; no voltage applied	no intermittent contacts no breakdown no open circuiting no mechanical damage $\Delta C/C: \pm 5\%$ $\tan \delta \leq 1.2 \times$ spec. limit $Z \leq 1.2 \times$ spec. limit $I_{L5} \leq 1.5 \times$ spec. limit
Severe rapid change of temperature		100 cycles of 1 hour duration, each with 30 minutes at -40 °C and $+125$ °C	$\Delta C/C: \pm 25\%$ $\tan \delta \leq 1.5 \times$ spec. limit $Z \leq 2.0 \times$ spec. limit $I_{L5} \leq 1 \times$ spec. limit
Solvent resistance	IEC 60068-2-45, test XA IEC 60653	immersion: 5 \pm 0.5 minutes with or without ultrasonic at 55 ± 5 °C solvents: demineralized water and/or calgonite solution (20 g/l)	visual appearance not affected
Passive flammability	IEC 60695-2-2	capacitor mounted to a vertical printed-circuit board, one flame on capacitor body; $T_{amb} = 20$ to 25 °C; test duration = 20 s	after removing the test flame from the capacitor, the capacitor must not continue to burn for more than 15 s; no burning particles must drop from the sample



ADDITIONAL TESTS AND REQUIREMENTS FOR EPOXY-FILLED VERSIONS SAL-AG

2222 123 6.... Form BA ±20%

2222 123 8.... Form BA ±10%, level S

Table 4

TEST PROCEDURES AND REQUIREMENTS		
TEST	PROCEDURE	REQUIREMENTS
Severe vibration tests in accordance with "IEC 60068-2-6" and "MIL STD-202", method 204, letter E, with the following details and additions		
Method of mounting: severity 1 severity 2 severity 1 and 2	clamping both body and leads frequency range temperature 10 to 3000 Hz; 20-25 °C frequency range temperature 50 to 2000 Hz; 125 °C vibration amplitude: 50 g or 3.5 mm, whichever is less	$\Delta C/C: \pm 10\%$ $\tan \delta \leq 1.2 \times \text{stated limit}$ $Z \leq 1.4 \times \text{stated limit}$ DC leakage current: $\leq \text{stated limit}$ no intermittent contacts no indication of breakdown no open circuiting no evidence of mechanical damage
Direction and duration of motion: severity 1 severity 2	1 octave/minute; 3 directions (mutually perpendicular); 20 sweeps per direction (total 60 sweeps or 18 hours) 1 octave/minute; 2 directions (longitudinal and transversal); 3 sweeps per direction (total 6 sweeps or 1 hour)	
Functioning: severity 1 severity 2	rated voltage applied no voltage applied	
Typical capability	>80 g at 10 to 3000 Hz (also at 125 °C)	
Severe shock tests in accordance with "IEC 60068-2-27" and "MIL STD-202", method 213, letter F, with the following details and additions:		
Method of mounting	clamping both body and leads	$\Delta C/C: \pm 10\%$ $\tan \delta \leq 1.2 \times \text{stated limit}$ $Z \leq 1.4 \times \text{stated limit}$ DC leakage current: $\leq \text{stated limit}$ no intermittent contacts no indication of breakdown no open circuiting no evidence of mechanical damage
Pulse shape: severity 1 severity 2 severity 3	half-sine or sawtooth 1500 g; 0.5 ms ("MIL STD-202", method 213, letter F) 3000 g; 0.2 ms 10000 g; 0.1 ms	
Direction and number of shocks: severity 1 and 2 severity 3	3 successive shocks in each direction of 3 mutually perpendicular axes (total 18 shocks) 1 shock in any direction	
Functioning	rated voltage applied	